

Data sheet

OpDAT pigtail SC-PC, OM3, 4 colors

Page 1/5

P/N
150M1CO0020E4
EAN 4251122189043
2025/05/28
Version: L

Illustrations

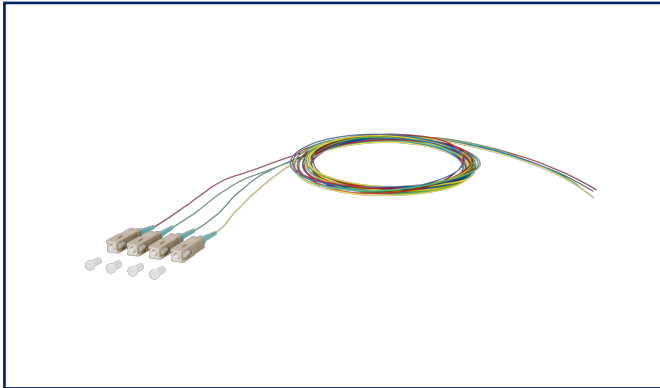

Dimensional drawing

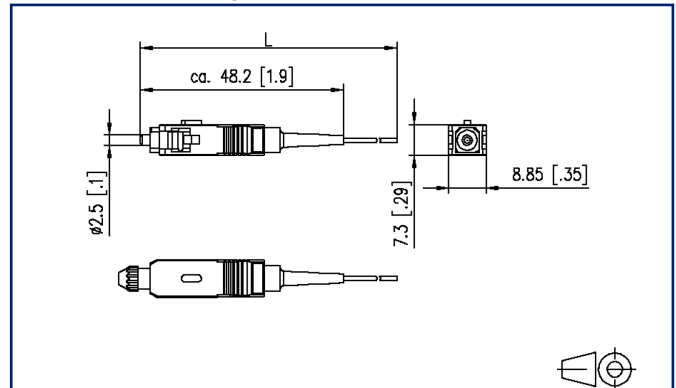

See enlarged drawings at the end of document

Product specification

- SC plug according to IEC 61754-4
- Multi mode fiber OM3, G50/125 μm , bend insensitive according to IEC 60793-2-10 type A1a.2
- Compact loose tube fiber with dia. 0.9 mm, length 2.0 m
- Color sequence in sets according to IEC 60304: red, green, blue, yellow, white, gray, brown, violet, turquoise, black, orange, pink. Secondary and primary coating same color
- Plug connector mounted on one side
- With test report, insertion loss and return loss tested at 100 %

- all available variants can be created with the cable configurator



OpDAT pigtail SC-PC, OM3, 4 colors

P/N
150M1CO0020E4
EAN 4251122189043
 2025/05/28
 Version: L

Technical Data

General Data

Fields of application	office areas data center
Mechanical measurement according to MICE	M1
Ingress measurement according to MICE	I1
Climatic measurement according to MICE	C1
Electromagnetic measurement according to MICE	E3
Design	pigtail
Transmission technology	Fiber optic
Color	beige
Dimensions	
Dimension (L x W x H)	48.2 mm x 8.85 mm x 7.3 mm
Dimension (L x W x H)	1.898 in. x 0.348 in. x 0.287 in.
Mode type of the fiber	Multimode
Fiber class	OM3
Fiber standard	IEC 60793-2-10/EN 60793-2-10 A1.a.2
Cable Type	pigtail(s)
Number of cables/ buffered fibers	4
Number of fibres each cable/ wire	1
Shape	PC (Physical Contact)
Fiber construction	50/125 µm
Cable length (m)	2 m
Cable length (ft)	6.56 ft

Connections/interfaces

Connector technology interface 1	SC PC
Connector technology interface 2	free line end
Primary coating diameter	0.25 mm
Primary coating diameter	0.01 in.
Secondary coating diameter	0.9 mm
Secondary coating diameter	0.035 in.
Ferrule diameter	2.5 mm
Ferrule diameter	0.098 in.

OpDAT pigtail SC-PC, OM3, 4 colors

P/N
150M1CO0020E4
EAN 4251122189043
 2025/05/28
 Version: L

Technical Data

Optical characteristics

Insertion loss	max. 0,4 dB
Return loss	min. 35 dB

Mechanical data

Insertion and withdrawal force	min. 5 N
Minimum bending radius	15 mm
Minimum bending radius	0.591 in.

Materials and material properties

Halogen free	yes
RoHS	compliant

Environmental conditions

Temperature (min. - max.)	
Temperature - Storage °C	-20 °C - 60 °C
Temperature - Storage °F	-4 °F - 140 °F
Temperature - Operating °C	-20 °C - 60 °C
Temperature - Operating °F	-4 °F - 140 °F

Standards/Regulations

Generic cabling systems	
General requirements	ISO/IEC 11801
Fibre optic connector interfaces	IEC 61754-4
Optical fibers: Product specifications	
Sectional specification for category A1 multimode fibres	ISO/IEC 60793-2-10 (A1a.2)
Optical fibers - Interconnecting devices and passive components - basic test and measuring methods	
Fibre optic interconnecting devices and passive components - Visual inspection of plug end face	IEC 61300-3-6
Standard colours for insulation for low-frequency cables & wires	IEC 60304
ITU-T standard	G.651.1

Data sheet

Page 4/5

OpDAT pigtail SC-PC, OM3, 4 colors

P/N

150M1CO0020E4

EAN 4251122189043

2025/05/28

Version: L

Technical Data**Classifications**

ETIM 7.0	EC000748
ETIM 8.0	EC000748
ETIM 9.0	EC000748

Packing details

Type of packaging	4 pc(s) / blister packaging
Packaging dimension	300 mm x 200 mm x 20 mm
Packaging dimension	11.811 in. x 7.874 in. x 0.787 in.

Application note

This product is a standard product of METZ CONNECT. METZ CONNECT is not aware of the specific intended use of the goods by the Customer or any customers of the Customer. The Customer guarantees that it has fully and sufficiently tested the use of the goods and any product modifications, product changes or product enhancements with regard to the specific intended use in accordance with the state of the art or in any other way. At METZ CONNECT's request, the Customer shall submit and make available meaningful evidence (e.g. test and laboratory protocols, certifications, etc.).



Illustrations

Dimensional drawing

