

Data sheet

PC board insert M12, A-coded, 4-pole, black

Page 1/5

P/N

MMT060A715-0001

EAN 4251394631820

2026/05/20

Version: R

Illustrations



Dimensional drawing

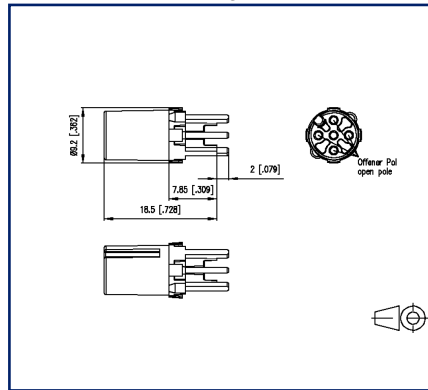

Drill pattern

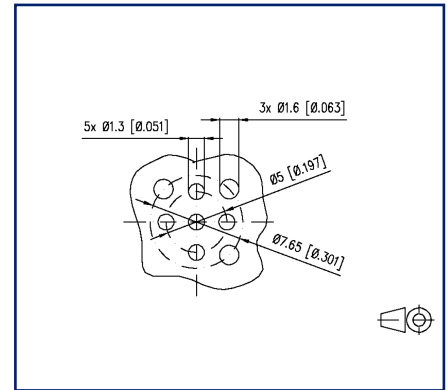

See enlarged drawings at the end of document

Product specification

- PC board insert M12
- 4-pole, A-coded according to IEC 61076-2-101
- THR solderable
- Top entry
- Contact carriers black
- suitable for applications in the railway industry according to data sheet



PC board insert M12, A-coded, 4-pole, black

P/N
MMT060A715-0001
EAN 4251394631820
 2026/05/20
 Version: R

Technical Data

General Data

Dimensions	
Dimension (D x H)	Ø 9.2 mm x 20.5 mm
Dimension (D x H)	0.362 in. x 0.807 in.
Ports	Single port
Solderability	Acc. to IPC/JEDEC J-STD-020E-MSL 1
Coding	A-coded

Electrical characteristics

Rated voltage	250 V
Effective value of the withstand voltage	1.4 kV
Current carrying capacity at 40 °C	4 A
Insulation resistance	min. 100 MOhm
Overvoltage category	II
Degree of pollution	2

Mechanical data

Material	
Material - Contact	CuZnPb
Contact surface	Ni + Au
Color	black
RoHS	pending
Life - Number of mating cycles	>= 100

Climatic properties

Temperature - Operating °C	-40 °C - 85 °C
Temperature - Operating °F	-40 °F - 185 °F

Approvals

Approval mark UL/CSA	E305050
----------------------	---------

Packaging

Type of packaging	10 pc(s) / blister packaging
-------------------	------------------------------

Data sheet

Page 3/5

PC board insert M12, A-coded, 4-pole, black

P/N

MMT060A715-0001

EAN 4251394631820

2026/05/20

Version: R

Technical Data**Standards/Regulations**

Railway applications

Insulating body	PA UL 94 V0 complies with HL1-HL3; R26 according to EN 45545-2:2020+A1:2023
-----------------	---

Flammable mass (g)	0.83 g
--------------------	--------

Classifications

ETIM 7.0	EC002637
----------	----------

ETIM 8.0	EC002637
----------	----------

Application note

This product is a standard product of METZ CONNECT. METZ CONNECT is not aware of the specific intended use of the goods by the Customer or any customers of the Customer. The Customer guarantees that it has fully and sufficiently tested the use of the goods and any product modifications, product changes or product enhancements with regard to the specific intended use in accordance with the state of the art or in any other way. At METZ CONNECT's request, the Customer shall submit and make available meaningful evidence (e.g. test and laboratory protocols, certifications, etc.).



Data sheet

Page 4/5

PC board insert M12, A-coded, 4-pole, black

P/N

MMT060A715-0001

EAN 4251394631820

2026/05/20

Version: R

Illustrations

Dimensional drawing

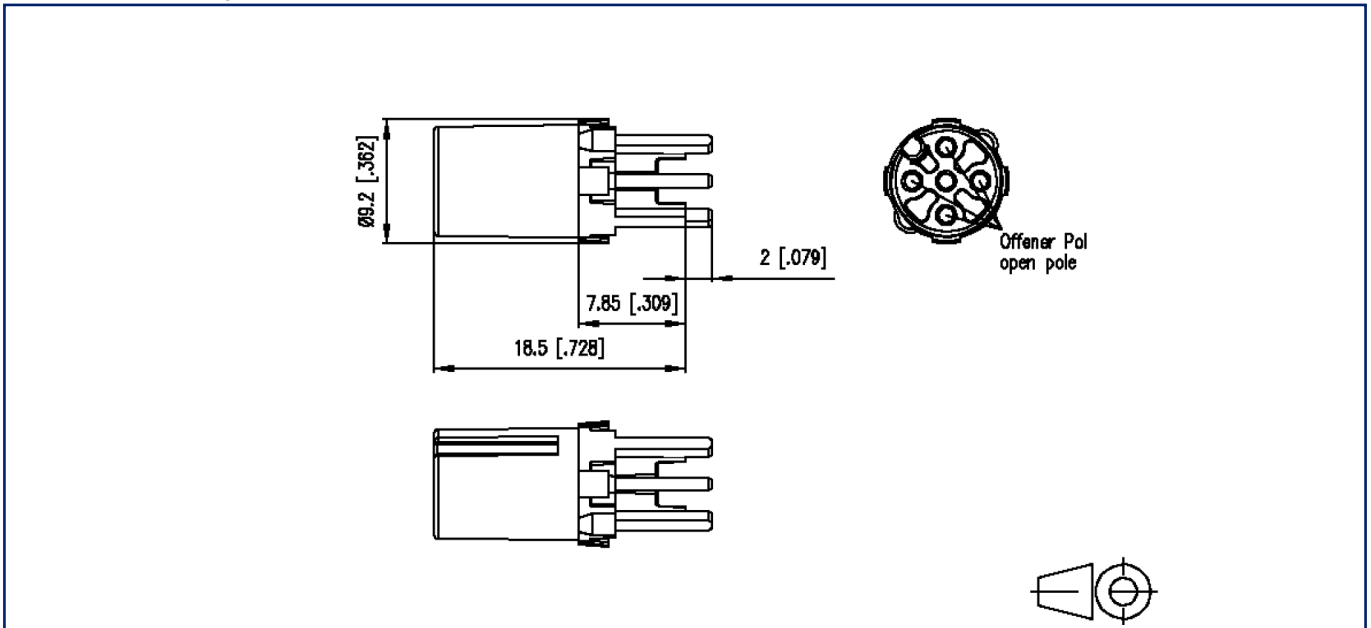

Drill pattern

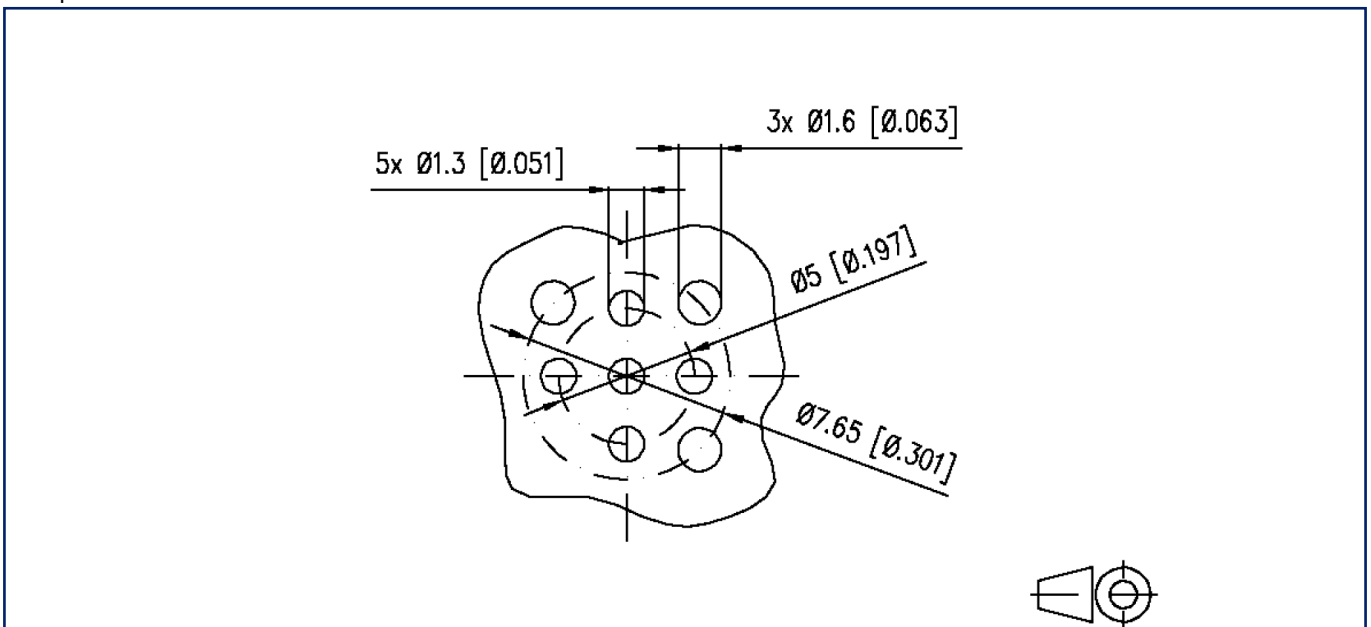

Illustrations

Snap-in geometry

