

Data sheet

M12 Bus-/Railcat connection cable, D-coded, 5.0 m, M12 plug - free line end, 4-pole, BETAtrans®

P/N
142MPD10050
EAN 4251394663906
2025/06/30
Version: D

Illustrations

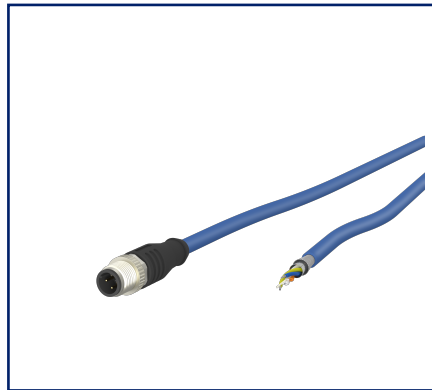

Dimensional drawing

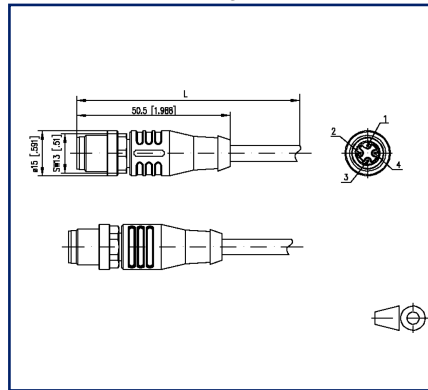

Wiring diagram

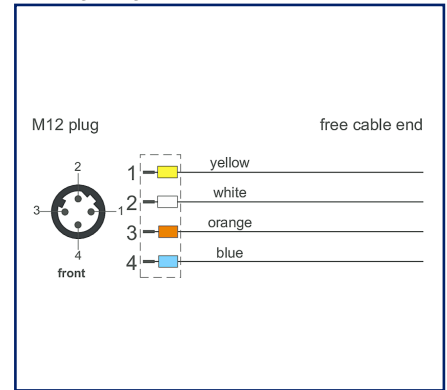

See enlarged drawings at the end of document

Product specification

Halogen-free, electron beam crosslinked Cat.5 data wire with improved behavior under fire conditions and increased temperature resistance. This wire is used in fixed and protected installation in railway vehicles and buses and meets the fire protection requirement according to EN 45545-2 (HL1 - HL3). It is optimally suited for applications of class D (ECN and ETB) according to IEEE 802.3. For installation, the notes according to EN 50355 and EN 50343 must be observed. Because of the thin wall thickness, this wire is especially useful for connecting the overmolded RJ45 connectors. BETAtrans® is a registered trademark of LEONI Studer AG, Switzerland. Special properties: flame retardant, LABS free, RoHs compliant, halogen free, increased thermal load capacity, low smoke emission, oil and fuel resistant, UN ECE-R 118.01 Fire protection: DIN EN 45545-2 HL1-3, DIN 5510 fire protection levels 1-4, NF F16-101 category A1, A2, B, UNI CEI 11170, danger level LR1-LR4, UN ECE-R 118.01

- Standard variants: 1.0 m, 2.0 m, 5.0 m, 10.0 m.
- Other cable lengths on request.

Data sheet

**M12 Bus-/Railcat connection cable, D-coded, 5.0 m,
M12 plug - free line end, 4-pole, BETAtrans[®]**

P/N
142MPD10050
EAN 4251394663906
2025/06/30
Version: D

Technical Data

General Data

Fields of application	Railway vehicle Buses
Applications	Train Communication Network: ETB– Ethernet Train Backbone
Design	Ethernet-Connection cable
Cable length (m)	5 m
Cable length (ft)	16.4 ft
Cable	
Cable Type	S/FTP
Wiring	Profinet
Wire color	yellow, white, orange, blue
Color - cable jacket	blue
Transmission properties	Cat.5
Connection 1	
Shielding	shielded
Dimension (L x W x H)	50.5 mm x 15 mm x 15 mm
Dimension (L x W x H)	1.988 in. x 0.591 in. x 0.591 in.

Connections/interfaces

Cable	
Conductor cross section AWG	AWG 22
Conductor diameter (mm)	0.75 mm
Conductor diameter (inch)	0.03 in.
Cable construction	1x4
Stranded wire structure	7x0.25mm
Outer diameter cable jacket (mm)	6.6 mm
Outer diameter cable jacket (inch)	0.26 in.
Connection 1	
Connector type	M12-plug
Coding	D-coded
Type of plug contact, field side	Male (plug)
Cable feed arrangement, field side	straight
Number of poles	4
Pin Assignment	1 YE, 2 WH, 3 OG, 4 BU

Data sheet

Page 3/8

**M12 Bus-/Railcat connection cable, D-coded, 5.0 m,
M12 plug - free line end, 4-pole, BETAtrans®**

P/N

142MPD10050

EAN 4251394663906

2025/06/30

Version: D

Technical Data

Connections/interfaces

Connection 1

Latching lever protection	no
Color of the cable boot	black

Electrical characteristics

Connection 1

Current carrying capacity per pin (at 40 °C)	4 A
--	-----

Mechanical data

Cable

Bending radius (fixed)	6 x Ø cable
------------------------	-------------

Connection 1

Mechanical life	min. 100 mating cycles
-----------------	------------------------

Materials and material properties

Cable

Material - Cable jacket	BETAtrans® Polyolefin Copolymer
Material - Wire insulation	BETAtrans® Cell PE
Flame retardancy	yes, according to IEC 60332-1-2
Halogen free	yes, according to EN 60754-1/2
Oil resistance	yes, according to EN IEC 60811-404
UV-resistance	yes

Connection 1

Material - Contact	CuZnPb (brass)
Material - Contact surface	Au (gold)
Material - Contact carrier	Plastics, PA, BK
Material - Body	Plastics, TPU, BK
Material - Cap nut	Metal, CuZn, nickel-plated

RoHS	compliant
------	-----------

**M12 Bus-/Railcat connection cable, D-coded, 5.0 m,
M12 plug - free line end, 4-pole, BETAtrans®**

P/N
142MPD10050
EAN 4251394663906
2025/06/30
Version: D

Technical Data

Environmental conditions

Cable	
Temperature range (fixed)	-40 °C - max. 85 °C
Temperature range (fixed)	-40 °F - 185 °F
Connection 1	
	-40 °C
	-40 °F
Protection category (mounted)	IP67 (-30 °C...+90 °C), IP65 (-40 °C...+90 °C)
Operating temperature classes	OT1 - OT4
Operating temperature range	-40 to 70

Standards/Regulations

General requirements	ISO/IEC 11801-1 DIN EN 50173-1
Cable	
Railway vehicle - Electronic equipment on railway vehicles	DIN EN 50155:2021
Railway vehicle - Fire protection in railway vehicles	DIN EN 45545-2:2020 Hazard Level 1-3
Railway vehicle - Preventive fire protection in railway vehicles	DIN 5510-2:2009-05 Fire protection levels 1-4
Railway vehicle - Fire behaviour Material selection	UNI CEI 11170-1/2/3 Hazard level LR1-LR4
Buses - Fire safety	UN ECE-R 118.01
Connection 1	
Circular connector	DIN EN 61076-2-101:2013
Shock and vibration	Class 1, category B (DIN EN 61373)
Degrees of Protection Provided by Enclosures	EN 60529:1991 + A1:2000 + A2:2013
Railway vehicle - Electronic equipment on railway vehicles	DIN EN 50155:2021
Railway vehicle - Fire protection in railway vehicles	DIN EN 45545-2:2020 Hazard Level 1-3

Classifications

ETIM 8.0	EC002599
ETIM 9.0	EC002599
ETIM 10.0	EC002599

Data sheet

Page 5/8

**M12 Bus-/Railcat connection cable, D-coded, 5.0 m,
M12 plug - free line end, 4-pole, BETAtrans[®]**

P/N

142MPD10050

EAN 4251394663906

2025/06/30

Version: D

Technical Data**Packing details**

Type of packaging	1 pc(s) / plastic bag
-------------------	-----------------------

Application note

This product is a standard product of METZ CONNECT. METZ CONNECT is not aware of the specific intended use of the goods by the Customer or any customers of the Customer. The Customer guarantees that it has fully and sufficiently tested the use of the goods and any product modifications, product changes or product enhancements with regard to the specific intended use in accordance with the state of the art or in any other way. At METZ CONNECT's request, the Customer shall submit and make available meaningful evidence (e.g. test and laboratory protocols, certifications, etc.).



Data sheet

Page 6/8

**M12 Bus-/Railcat connection cable, D-coded, 5.0 m,
M12 plug - free line end, 4-pole, BETAtrans[®]**

P/N

142MPD10050

EAN 4251394663906

2025/06/30

Version: D

Accessories

P/N	Designation
MMF881A115	M12 jack, D-coded, IP67, Cat.5, Ø 6-9.7 mm, field assembly, straight
MMF881A115-0001	M12 jack, D-coded, IP67, Cat.5, Ø 6-9.7 mm, field assembly, with flange
MNF881A115	M12 plug, D-coded, IP67, Cat.5, Ø 6-9.7 mm, field assembly, straight
MWN811A115	M12 Panel feed through adapters, D-coded, to RJ45 - straight



Data sheet

Page 7/8

**M12 Bus-/Railcat connection cable, D-coded, 5.0 m,
M12 plug - free line end, 4-pole, BETAtrans®**

P/N

142MPD10050

EAN 4251394663906

2025/06/30

Version: D

Illustrations

Dimensional drawing

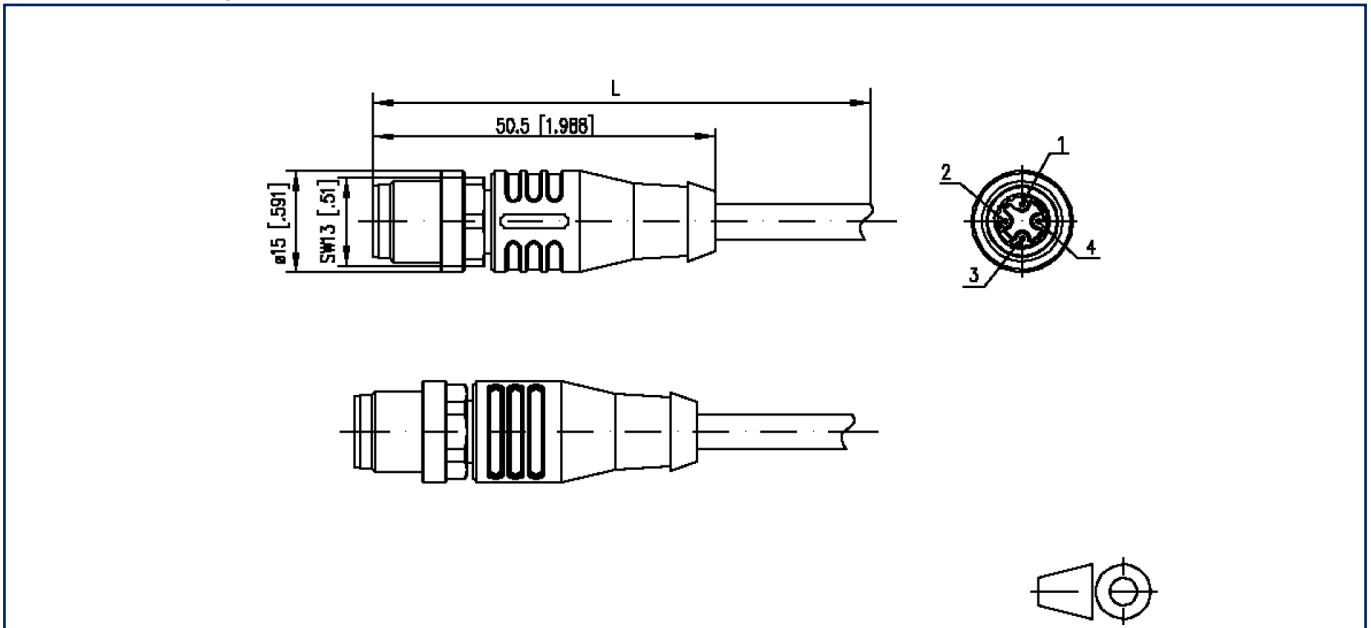

Wiring diagram

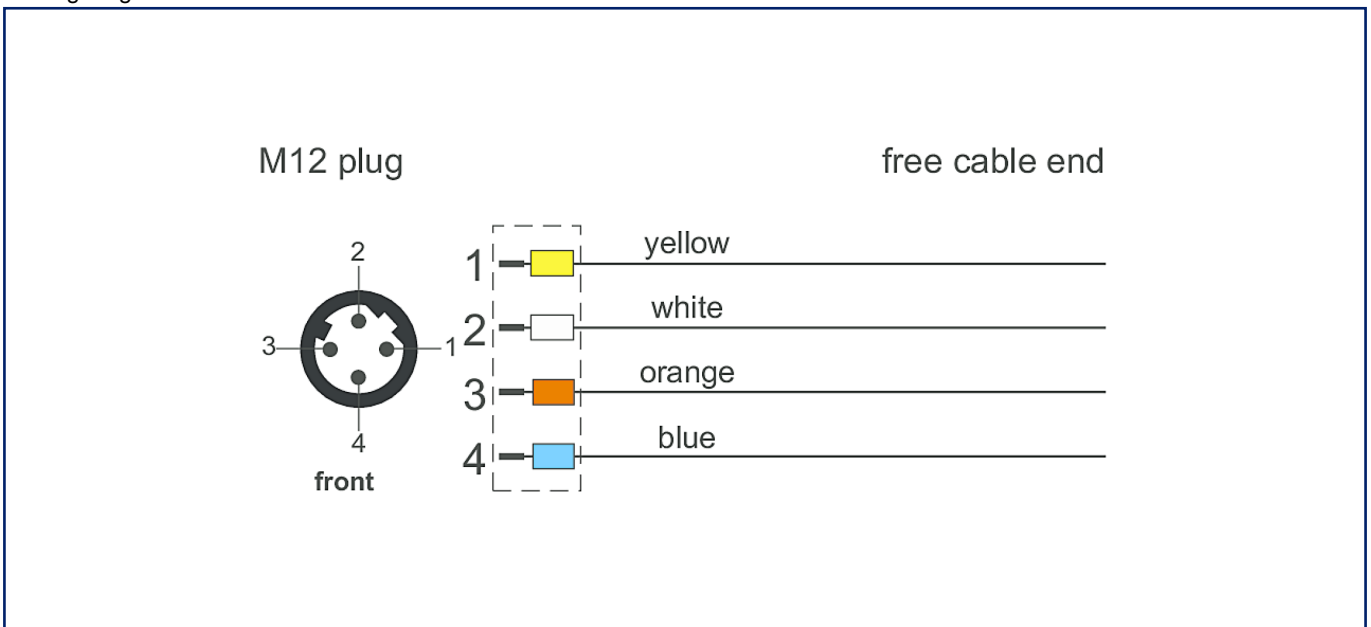

Data sheet

Page 8/8

**M12 Bus-/Railcat connection cable, D-coded, 5.0 m,
M12 plug - free line end, 4-pole, BETAtrans[®]**

P/N

142MPD10050

EAN 4251394663906

2025/06/30

Version: D

Illustrations

Principle diagram

