

DCCS – The future-oriented solution for your data center

10G 25G 100G



The compact solution for performance upgrades

Data centers are at the heart of every network, no matter what tasks it is intended for. The demands on performance and capacity are increasing rapidly. A network connects very different areas and the type of data processed ranges from simple text documents to complex construction drawings, from production control to building management.

The huge volumes of data that need to be processed and archived quickly push today's networks to their limits, meaning that expansions become inevitable. The result is that compact, cost-effective, fast and, above all, user-friendly solutions are needed to make optimum use of the available space and keep downtimes to a minimum.

The DCCS (Data Center Compact Solution) product range was developed specifically for data centers and their needs and extensively adapted to customer requirements in this area.

The DCCS system is based on a 19 inch subrack with 1 height unit, in which pre-terminated copper and fiber optic links (subassemblies connected with cables) can be simply installed modularly. Various other subassemblies are additionally available. Up to 48 copper or 48 fiber optic duplex/fiber optic MPO/MTP® connections as well as combinations of both transmission technologies can thus be accommodated on just one height unit.

i

Fiber optic (FO) features

- > Transmission technology GBit-Ethernet from 10 to 100 GBit/s
- > All DCCS products are available for or with multi-mode fiber type OM3, OM4, OM5 and single mode fiber OS2.
All fiber types are resistant to bending
- > Plug types LC-Duplex, E2000-Duplex and MPO/MTP® (12 fibers).
Duplex connectors are also available in grade B quality class
- > DCCS products with terminated connectors are provided with a serial number and are 100% tested for insertion and return loss. Measurement record enclosed

Copper features

- > with Cat.6A component testing in accordance with ISO/IEC 11801-1, ANSI/TIA-586.2-D and IEC 60603-7-51, GHMT certified
- > compliance with class E_A up to 500 MHz according to ISO/IEC 11801-1, GHMT certified
- > suitable for ultra short links (under 5 m)
- > suitable for Remote Powering (PoE, PoE plus, UPoE and 4PPoE), HDBaseT, SAT-IP and AVoverIP
- > cable connection via LSA cutting terminal blocks on the DCCS C6A MTC6 for 6 single cables S/FTP 4P
- > cable connection via LSA cutting terminal blocks on the DCCS C6A MTC1 for a multi pair cable S/FTP 24P
- > for 10 GBit-Ethernet (IEEE 802.3an)



Product variants



DCCS LINK

DCCS links are pre-terminated links for direct connection of two DCCS subracks. The cable used is pre-terminated on both sides with fiber optic connectors, which are placed on adapters in the DCCS housings. The cable length is manufactured according to customer requirements. Installation is simple and safe.



DCCS LINK VIK

DCCS links VIK are pre-terminated links with cables terminated on both ends, the second end of which is not placed in a DCCS housing, but can be easily installed with a pulling aid, even in tight spaces such as in cable ducts. The connectors on the open cable end can be placed in a DCCS subassembly or also in another 19-inch patch panel after the cable has been laid. The cable length is manufactured according to customer requirements.



DCCS SUBASSEMBLIES

These are used to accommodate pre-terminated mini breakout cables (VIK), for example. Strain relief is achieved via M20 cable gland (included in the delivery contents) or by using the mounting set delivered on the VIK.



DCCS SUBASSEMBLIES WITH FANOUT

Subassemblies with installed LC-MTP®-Fanout for splitting or combining duplex on multi-fiber cables. A MTP® trunk cable is connected to the back, whilst the connection is made on the front using LC-Duplex patch cords.



DCCS SUBRACKS

The subrack (19Zoll/1HE) allows up to 8 DCCS housings to be accommodated. Unoccupied spaces can be sealed with blind modules (accessories). It is also possible to mount and remove the housing with the subrack already installed.

Applications

Design example with duplex connectors for multi-mode applications

ETHERNET PROTOCOLS (IEEE 802.E)		CONNECTOR	WAVELENGTH	MAX. RANGE FOR FIBER TYPE (DEPENDING ON TRANSCEIVER)		
				OM3	OM4	OM5
10 GBit/s	10GBASE-SR	LC-D	850 nm	300 m	400 m	550 m
25 GBit/s	25GBASE-SR	LC-D	850 nm	70 m	100 m	100 m
40 GBit/s	40GBASE-SWDM4	LC-D	WDM from 850 nm	-	-	300 m
50 GBit/s	50GBASE-SR	LC-D	850 nm	70 m	100 m	100 m
100 GBit/s	100GBASE-SWDM4	LC-D	WDM from 850 nm	-	-	300 m

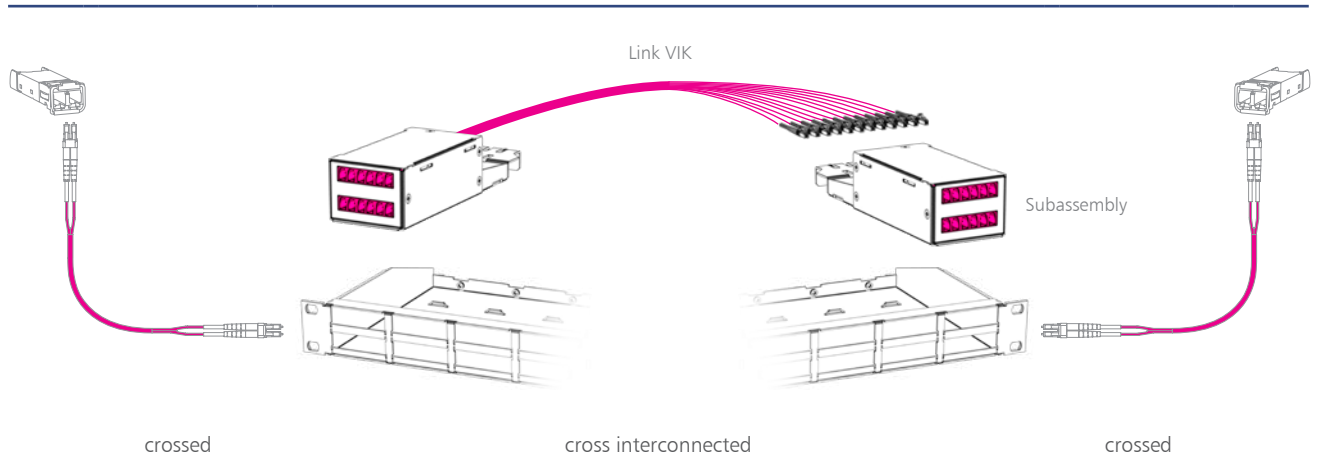
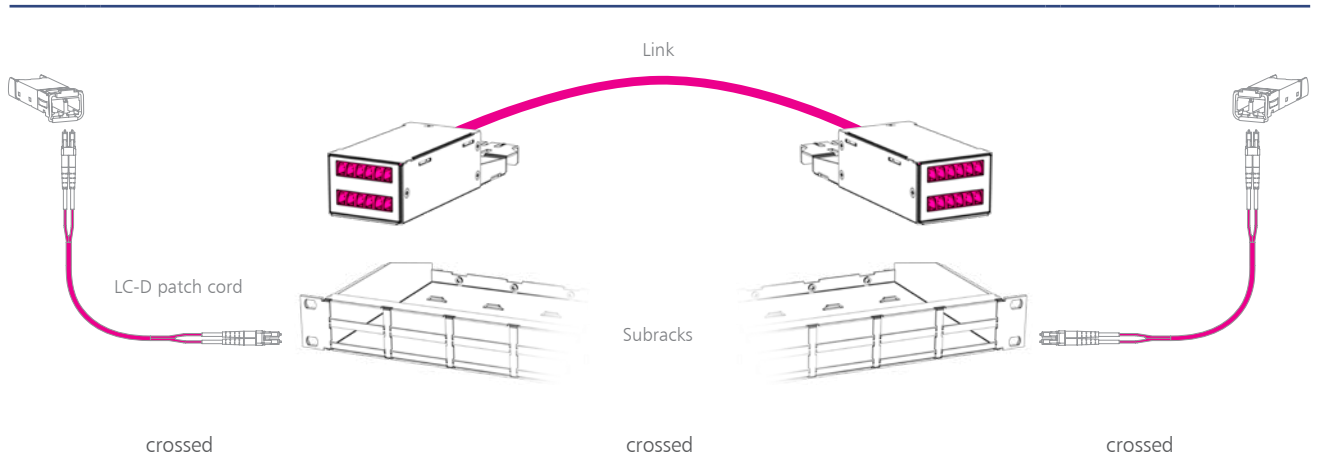

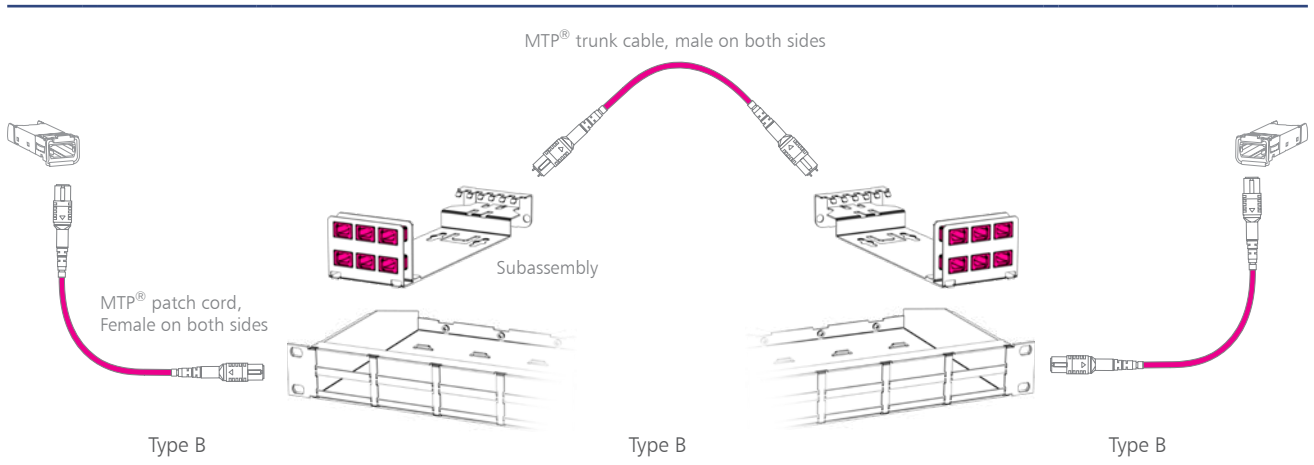
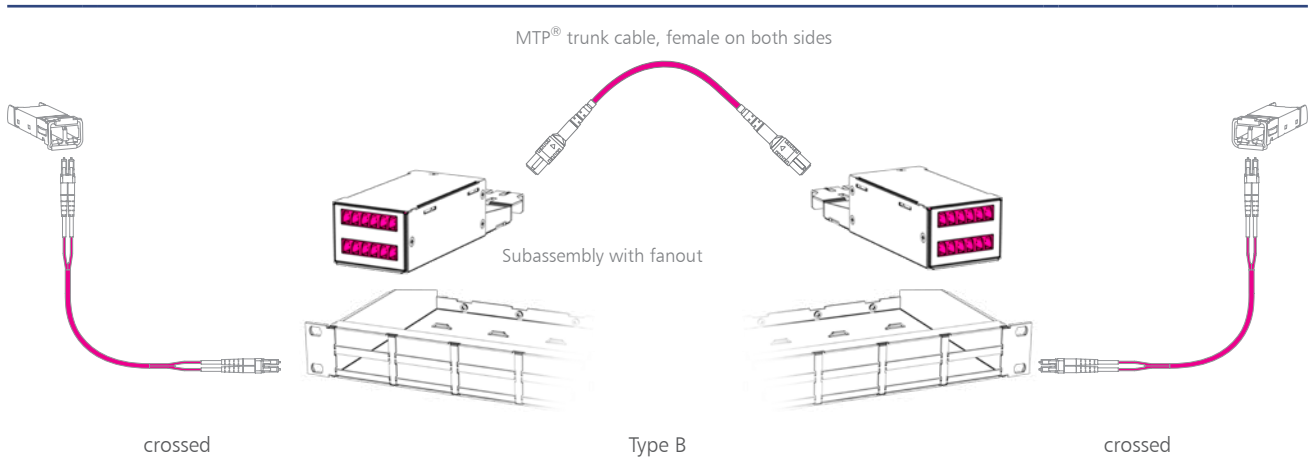
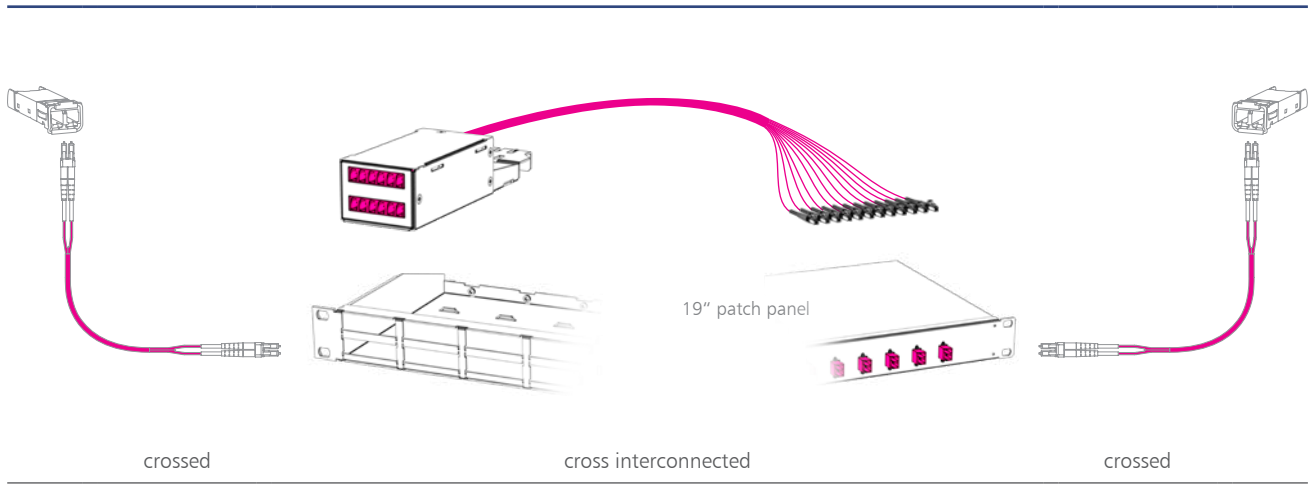

Applications



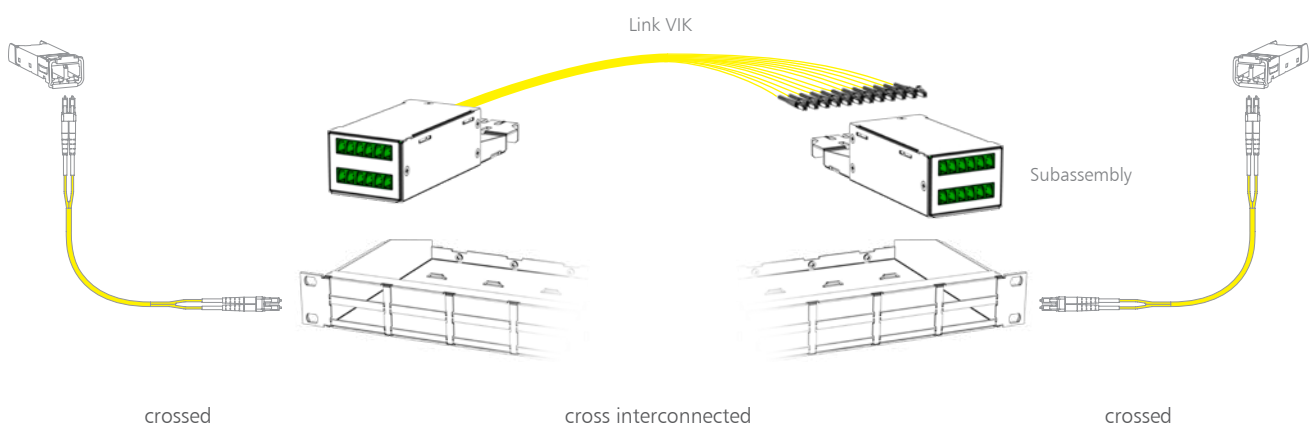
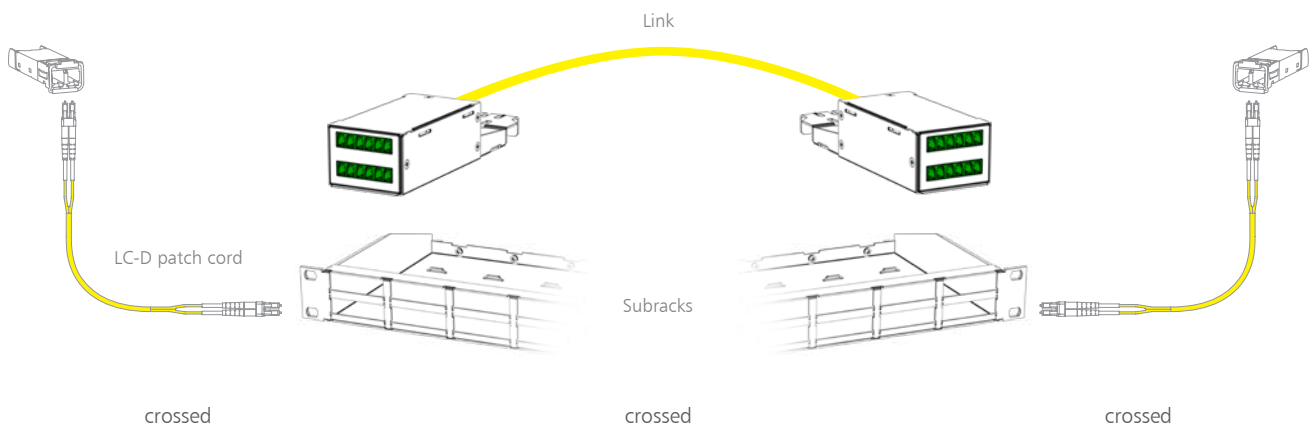

Design example with duplex connectors for **single-mode applications**

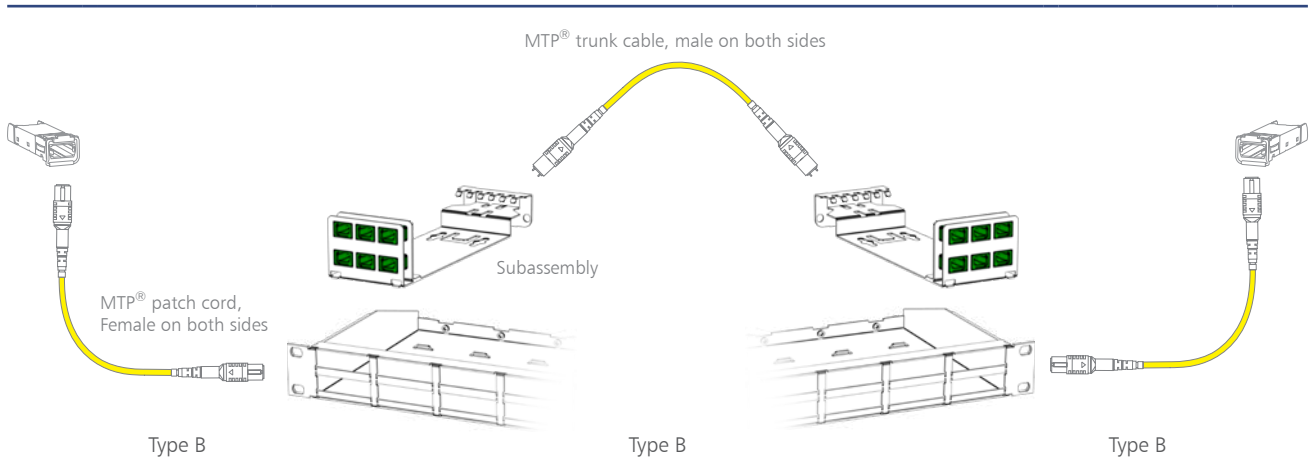
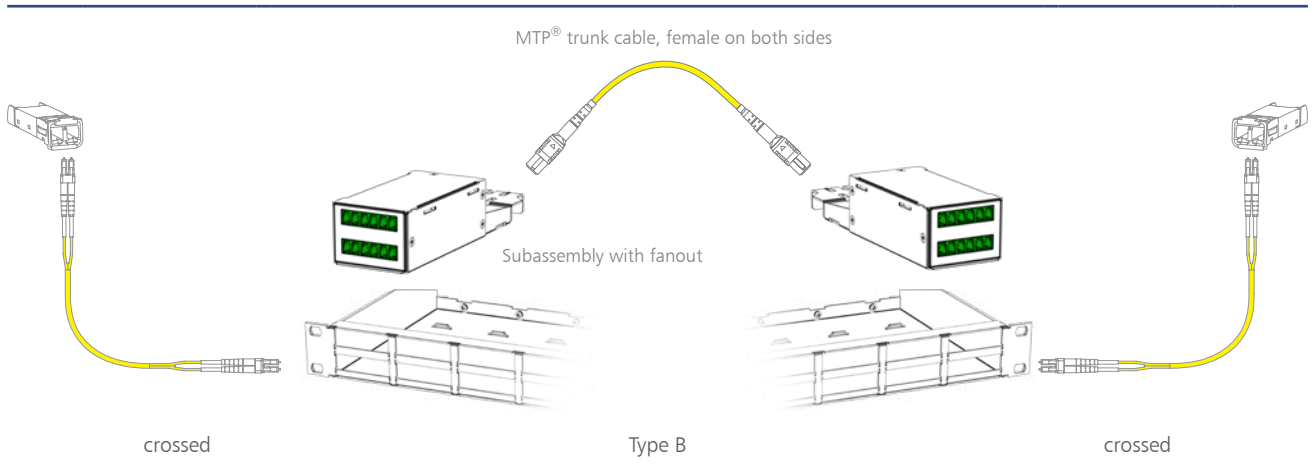
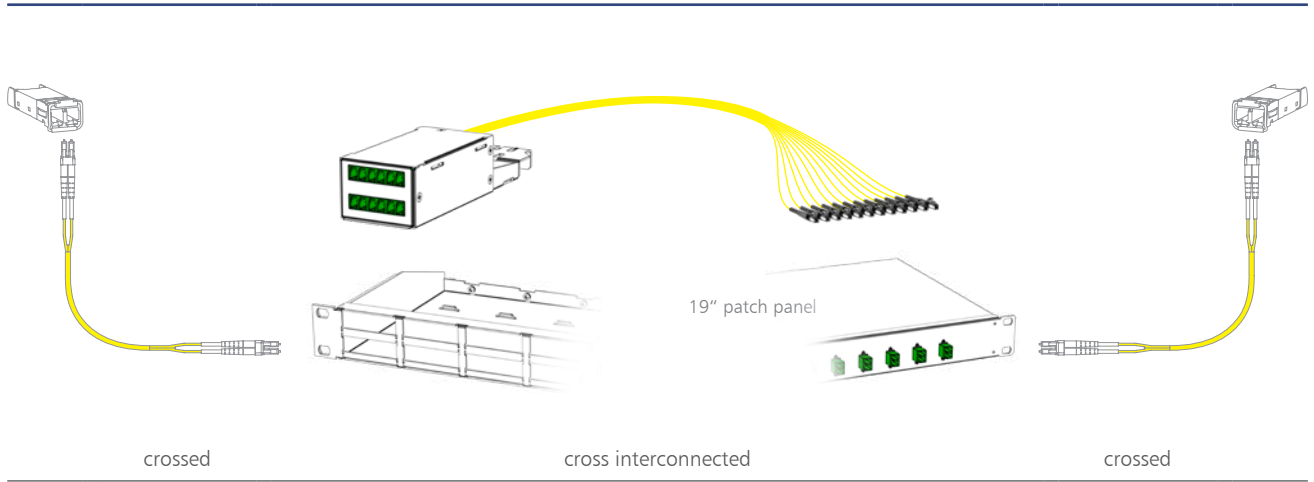
ETHERNET PROTOCOLS (IEEE 802.E)		CONNECTOR	WAVELENGTH	MAX. RANGE FOR FIBER TYPE (DEPENDING ON TRANSCEIVER)
10 GBit/s	10GBASE-LX4	LC-D	WDM around 1310 nm	OS2 10 km
10 GBit/s	10GBASE-LR	LC-D	1310 nm	25 km
10 GBit/s	10GBASE-ER	LC-D	1550 nm	40 km
40 GBit/s	40GBASE-LR4	LC-D	WDM around 1310 nm	10 km
100 GBit/s	100GBASE-LR4	LC-D	WDM around 1310 nm	10 km
100 GBit/s	100GBASE-ER4	LC-D	WDM around 1310 nm	40 km





Your DCCS products for fiber optic cabling

	PRODUCT NAME	FIBER TYPE	ADAPTERS	ASSIGNMENT	P/N
 DCCS Link		OM4	6xLC-D / 6xLC-D	crossed	130D2F7JJBxxxE
		OM5	6xLC-D / 6xLC-D	crossed	130D2F8JJBxxxE
		OS2	6xLC-D / 6xLC-D	crossed	130D2F9JJBxxxE
		OS2	6xLC-D APC / 6xLC-D APC	crossed	130D2F9KKBxxxE
		OS2	6xE2000-D APC / 6xE2000-D APC	crossed	130D2F9QQBxxxE
 DCCS Link VIK		OM4	6xLC-D / 6xLC-D		130D2F7JJ5xxxN
		OM5	6xLC-D / 6xLC-D		130D2F8JJ5xxxN
		OS2	6xLC-D / 6xLC-D		130D2F9JJ5xxxN
		OS2	6xLC-D APC / 6xLC-D APC		130D2F9KK5xxxN
		OS2	6xE2000-D APC / 6xE2000-D APC		130D2F9QQ5xxxN
 DCCS subassembly		OM4	6xLC-D		130D207J00000N
		OM5	6xLC-D		130D208J00000N
		OS2	6xLC-D		130D209J00000N
		OS2	6xLC-D APC		130D209K00000N
 DCCS subassembly		OM4	6xMTP®	Type A	130D207M00000A
				Type B	130D207M00000B
		OM5	6xMTP®	Type A	130D208M00000A
				Type B	130D208M00000B
		OS2	6xMTP®	Type A	130D209M00000A
 DCCS subassembly with fanout		OM4	6xLC-D / 1xMTP®	Type B	130D217JM0000B
		OM5	6xLC-D / 1xMTP®	Type B	130D218JM0000B
		OS2	6xLC-D / 1xMTP®	Type B	130D219JM0000B
		OS2	6xLC-D APC / 1xMTP®	Type B	130D219KM0000B

Fiber optic accessories

	PRODUCT NAME	FIBER TYPE	CONNECTOR	ASSIGNMENT	P/N
 <p>Patch cord (2.0 mm)</p>		OM4	LC-D / LC-D	crossed	151S1JOJOxxE
		OM5	LC-D / LC-D	crossed	151R1JOJOxxE
		OS2	LC-D / LC-D	crossed	151P1JOJOxxE
		OS2	LC-D APC / LC-D APC	crossed	151P1JAJAxxE
		OS2	E2000-D APC / E2000-D APC	crossed	151P1MAMAxxE
 <p>MTP® patch cord (2.0 mm)</p>		OM4	MTP-F / MTP-F	Type B	151SATFTF0xxB
		OM5	MTP-F / MTP-F	Type B	151RATFTF0xxB
		OS2	MTP-F / MTP-F	Type B	151PATFTF0xxB
 <p>MTP® trunk cable (4.5 mm)</p>		OM4	MTP-F / MTP-F	Type B	151SPTFTF0xxA
		OM5	MTP-F / MTP-F	Type B	151RPTFTF0xxA
		OS2	MTP-F / MTP-F	Type B	151PPTFTF0xxA
		OM4	MTP-M / MTP-M	Type B	151SPTMTM0xxA
		OM5	MTP-M / MTP-M	Type B	151RPTMTM0xxA
		OS2	MTP-M / MTP-M	Type B	151PPTMTM0xxA

All length specifications are represented by placeholders (x) in the above part numbers.







Configure your DCCS links according to your individual wishes.

Our configurators, including ones for patch cords, can be found on our homepage at www.metz-connect.com.

Configure and inquire directly.



Your DCCS products for copper cabling

	PRODUCT NAME	PROPERTIES	VARIANTS	P/N
	DCCS subassembly C6 _A	For a 24p cable	MTC1	130D2CM1-E
		For six 4p cables	MTC6	130D2CM6-E
	DCCS2 C6 _A permanent link	Class E _A permanent link, consisting of 2 subassemblies 6 port RJ45, fitted to a 24-pair installation cable	With AWG 26 up to 50 m	130D2CL1xxxE*
			With AWG 23 up to 80 m	130D2CL2xxxE*
	DCCS subassembly 4 port unequipped		For installation type Module	130D2CBU4-E
	DCCS subassembly 4 port unequipped		For installation type Keystone	130D2CKU4-E
	DCCS subassembly 6 port RJ45 - Cross Connect	Equipped with 6 feed-through adapters		130D2CMC6-E
	DCCS subassembly 6 port - RJ45	Equipped with 6 modules (T568 _A)	6x RJ45 module	130D2CMM6-E
	DCCS2 subassembly unequipped		For E-DAT Industry Inserts	130D2CMU6-E

* xxx for copper represents the following lengths: 050 = 5 m; 100 = 10 m; 200 = 20 m; 500 = 50 m

DCCS accessories

	PRODUCT NAME	PROPERTIES	P/N
	Blind module		130DBL1-E
	Subracks	gray	130D2B1G-E
		black	130D2B1B-E
	Cable interception DCCS	for 8x VIK dividers	130D2Z0101-B
	Cable interception DCCS	for 8x M20/ M25 screw connections	130D2Z0102-B
	Consolidation Point	For installation of 2 DCCS housings (links or subassemblies)	15030D0000-E
	Patch panel 1RU		130894-01-29-E
	Labeling for patch panel 1RU		130894-BS-29-E

Suitable modules for DCCS

Installation type: Module



Installation type: Keystone



Installation type: Industry module



Notes

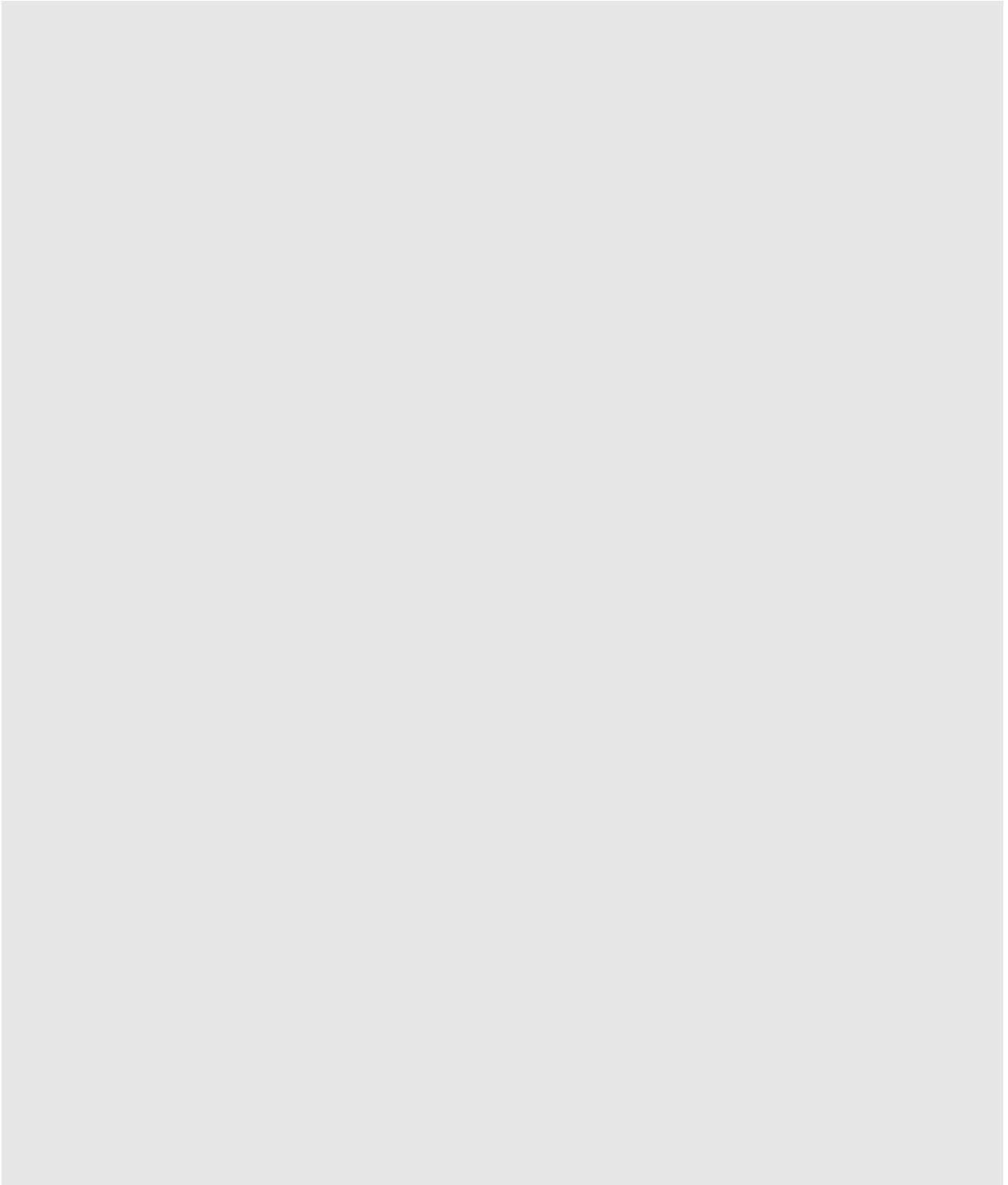

DCCS cable interception

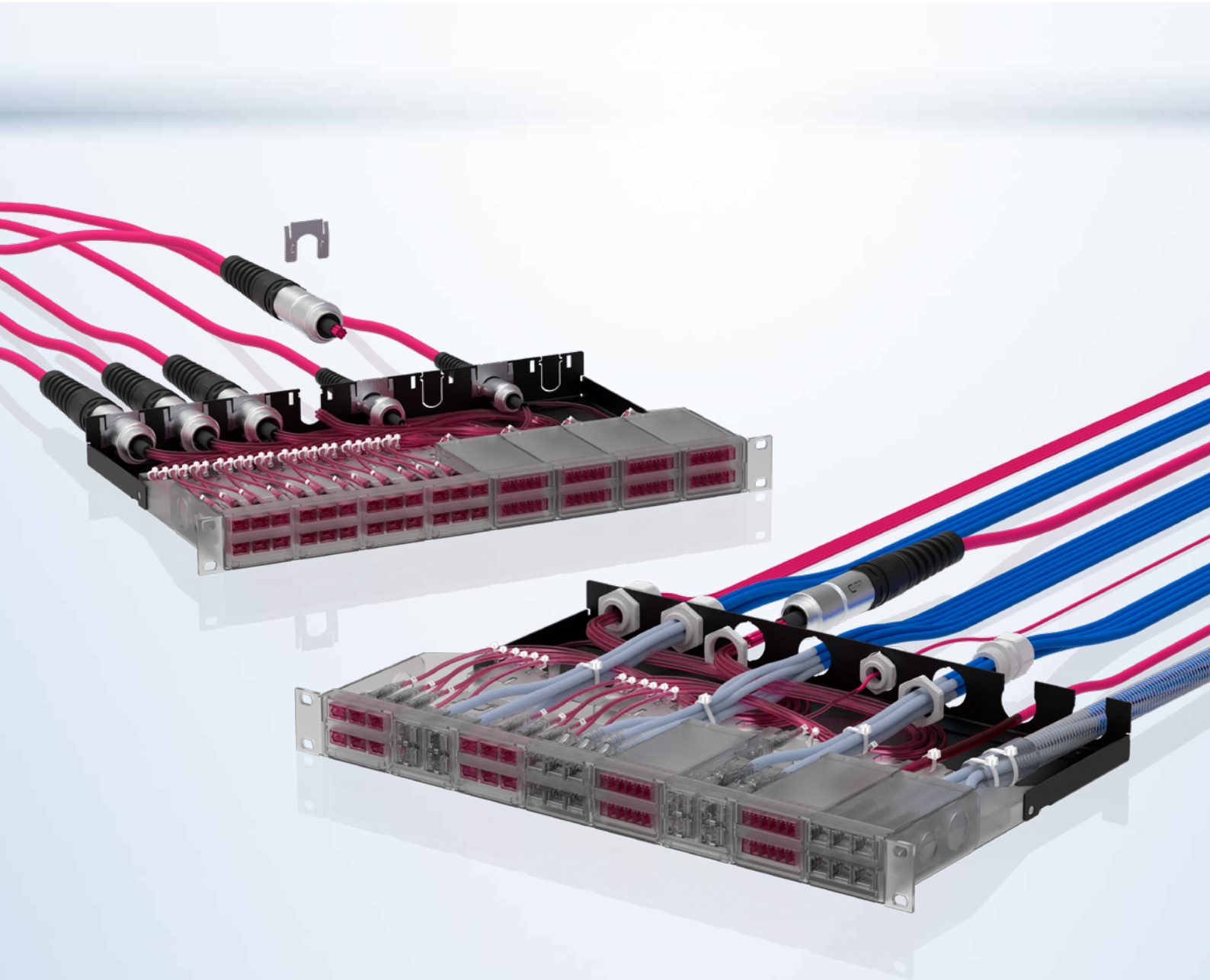

The DCCS cable clamp is an extension module for the DCCS subrack. It can be used to securely fasten incoming, pre-assembled cables to the subrack and also provides space for tidy storage of the cable whips. Installation is possible at any time without having to remove previously installed modules.

VIK (pre-assembled installation cables)

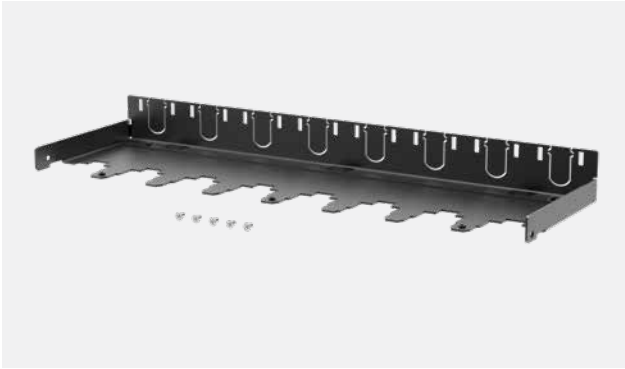

130D2Z0101-B

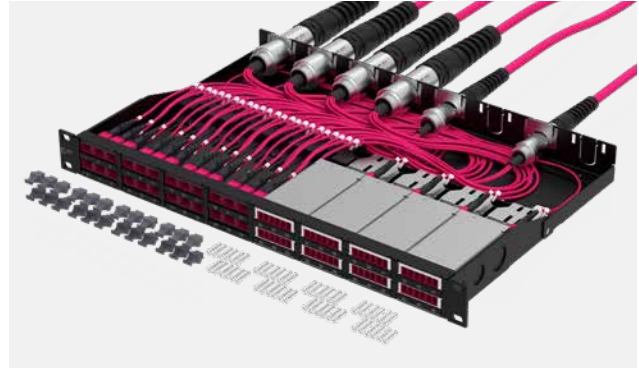

Application example

M20/M25

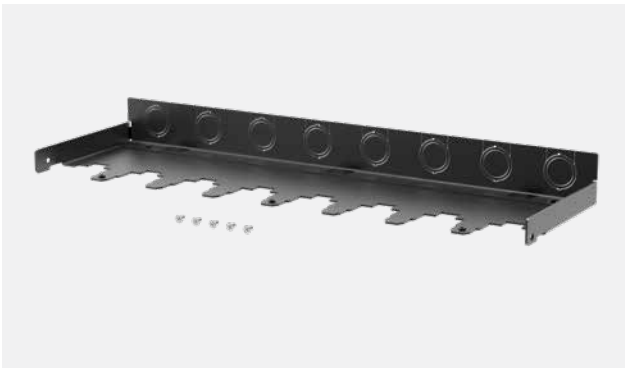

130D2Z0102-B



Application example

Dimensional drawing (single)

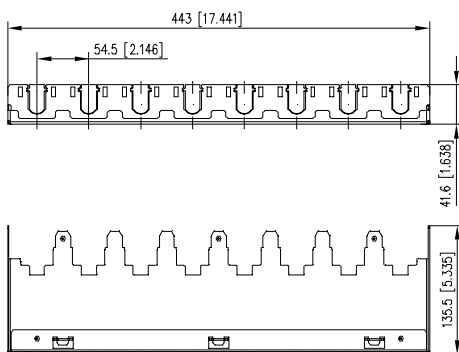

Dimensional drawing (mounted)

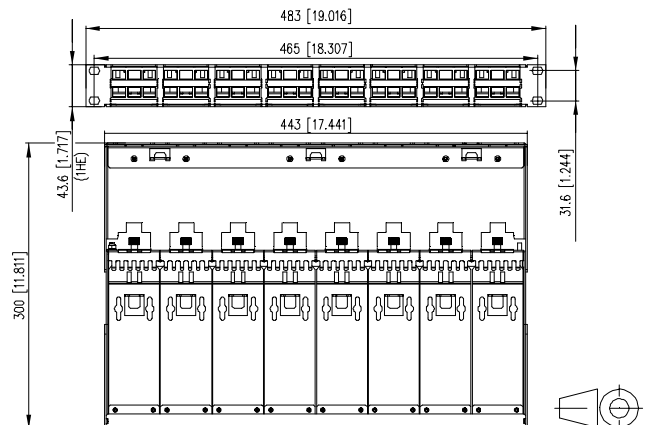



We realize ideas

METZ CONNECT GmbH

Im Tal 2
78176 Blumberg
Germany

Phone +49 7702 533-0
Fax +49 7702 533-189

info@metz-connect.com
www.metz-connect.com

METZ CONNECT USA Inc.

200 Tornillo Way
Tinton Falls, NJ 07712
USA

Phone +1 732 389 1300
Fax +1 732 389 9066

METZ CONNECT France SAS

28, Rue Schweighaeuser
67000 Strasbourg
France

Phone +33 3886 17073
Fax +33 3886 19473

METZ CONNECT AUSTRIA GmbH
c/o German chamber of commerce
in Austria

Schwarzenbergplatz 5, Top 3/1
1030 Vienna
Austria

Phone +43 1 227 12 64
Fax +43 1 227 12 66

METZ CONNECT Zhongshan Ltd.

Ping Chang Road
Ping Pu Industrial Park
Sanxiang Town
Zhongshan City, 528463
Guangdong Province
China

Phone +86 760 86365 055
Fax +86 760 86365 050

METZ CONNECT Asia Pacific Ltd.

Suite 1803, 18/F
Chinachem Hollywood Centre,
1 Hollywood Road, Central
Hong Kong

Phone +852 26 027 300
Fax +852 27 257 522

