

Data sheet

OpDAT pigtail ST-UPC, OS2, 8 color

Page 1/6

P/N
150Q1AO0020E8
EAN 4251122189272
2025/09/18
Version: P

Illustrations

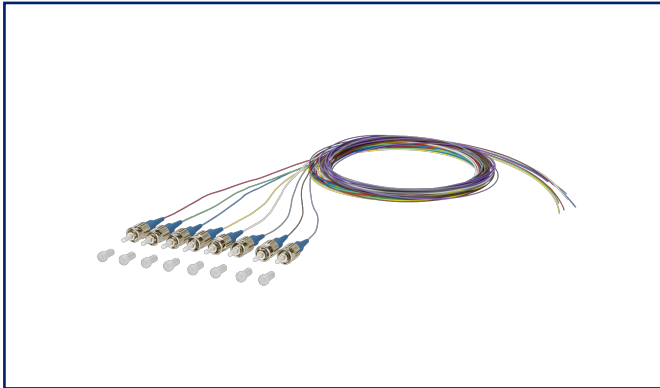

Dimensional drawing

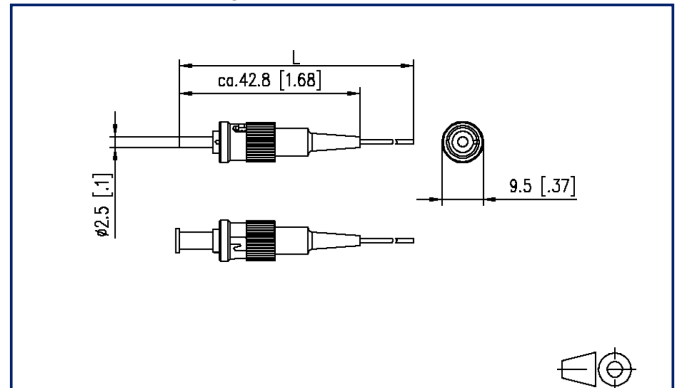

See enlarged drawings at the end of document

Product specification

- ST plug according to IEC 61754-2
- Single mode fiber OS2, E9/125 μm , bend insensitive according to IEC 60793-2-50 type B6_a and G.657.A1 compatible to G.652.D
- Compact loose tube fiber with dia. 0.9 mm, length 2.0 m
- Color sequence in sets according to IEC 60304: red, green, blue, yellow, white, gray, brown, violet, turquoise, black, orange, pink. Secondary and primary coating same color
- Plug connector mounted on one side
- With test report, insertion loss and return loss tested at 100 %
- all available variants can be created with the cable configurator



OpDAT pigtail ST-UPC, OS2, 8 color

P/N
150Q1AO0020E8
EAN 4251122189272
 2025/09/18
 Version: P

Technical Data

General Data

Fields of application	office areas data center
Mechanical measurement according to MICE	M1
Ingress measurement according to MICE	I1
Climatic measurement according to MICE	C1
Electromagnetic measurement according to MICE	E3
Design	pigtail
Transmission technology	Fiber optic
Color	metallike
Dimensions	
Dimension (L x W x H)	42.8 mm x 9.5 mm x 9.5 mm
Dimension (L x W x H)	1.685 in. x 0.374 in. x 0.374 in.
Mode type of the fiber	Singlemode
Fiber class	OS2
Fiber standard	ITU-T G.657.A1, IEC 60793-2-50 B1.3 B6_a
Cable Type	pigtail(s)
Number of cables/ buffered fibers	8
Number of fibres each cable/ wire	1
Shape	UPC (Ultra Physical Contact)
Fiber construction	9/125 µm
Cable length (m)	2 m
Cable length (ft)	6.56 ft

Connections/interfaces

Connector technology interface 1	ST UPC
Connector technology interface 2	free line end
Primary coating diameter	0.25 mm
Primary coating diameter	0.01 in.
Secondary coating diameter	0.9 mm
Secondary coating diameter	0.035 in.
Ferrule diameter	1.25 mm
Ferrule diameter	0.049 in.

OpDAT pigtail ST-UPC, OS2, 8 color

P/N
150Q1AO0020E8
 EAN 4251122189272
 2025/09/18
 Version: P

Technical Data

Optical characteristics

Insertion loss	max. 0,4 dB
Return loss	min. 50 dB

Mechanical data

Insertion and withdrawal force	min. 5 N
Minimum bending radius	15 mm
Minimum bending radius	0.59 in.

Materials and material properties

Material - Housing	metal
Bend insensitivity	yes
Halogen free	yes
RoHS	compliant

Environmental conditions

Temperature (min. - max.)	
Temperature - Storage °C	-20 °C - 60 °C
Temperature - Storage °F	-4 °F - 140 °F
Temperature - Operating °C	-20 °C - 60 °C
Temperature - Operating °F	-4 °F - 140 °F

Standards/Regulations

Generic cabling systems	
General requirements	ISO/IEC 11801
Fibre optic connector interfaces	IEC 61754-2
Optical fibers: Indoor optical cables	
Sectional specification for classÂ B single-mode fibres	ISO/IEC 60793-2-50 type B.1.3 & B6_a
Optical fibers - Interconnecting devices and passive components - basic test and measuring methods	
Fibre optic interconnecting devices and passive components - Visual inspection of plug end face	IEC 61300-3-4 IEC 61300-3-6
ITU-T standard	G.657.A

Data sheet

Page 4/6

OpDAT pigtail ST-UPC, OS2, 8 color

P/N

150Q1AO0020E8

EAN 4251122189272

2025/09/18

Version: P

Technical Data**Classifications**

ETIM 7.0	EC000748
ETIM 8.0	EC000748
ETIM 9.0	EC000748
ETIM 10.0	EC000748

Packing details

Type of packaging 8 pc(s) / blister packaging

Application note

This product is a standard product of METZ CONNECT. METZ CONNECT is not aware of the specific intended use of the goods by the Customer or any customers of the Customer. The Customer guarantees that it has fully and sufficiently tested the use of the goods and any product modifications, product changes or product enhancements with regard to the specific intended use in accordance with the state of the art or in any other way. At METZ CONNECT's request, the Customer shall submit and make available meaningful evidence (e.g. test and laboratory protocols, certifications, etc.).



Data sheet

Page 5/6

OpDAT pigtail ST-UPC, OS2, 8 color

P/N

150Q1AO0020E8

EAN 4251122189272

2025/09/18

Version: P

Accessories

P/N	Designation
15090401-E	OpDAT crimp splice protection (12 pieces)
15090401-I	OpDAT crimp splice protection (150 pieces)
15090402-I	OpDAT shrink splice protection

Data sheet

Page 6/6

OpDAT pigtail ST-UPC, OS2, 8 color

P/N

150Q1AO0020E8

EAN 4251122189272

2025/09/18

Version: P

Illustrations

Dimensional drawing

